



Yuasa Technical Data Sheet

Yuasa M31-100 - Marine Batteries

Performance

Voltage	12V
Capacity (20-hour)	100Ah
Cold Cranking Amps (EN1)	600A

Dimensions

Length	330mm
Width	173mm
Height	240mm

Weights & Measures

Mean Weight with Acid	23.5kg
Dry Weight	-
Acid Volume	-

Container Features

Case Type	GR31 BCI
Cell Layout	1
Hold Down	N
State of Charge Indicator	✓
Handles	✓
End Venting	✓
Semi-Traction Features	✓
Lid Type	SMF Double Lid



Technology

Flame Arrestor	✓
Technology	Ca/Ca
Separator	PE
VDA Roll Over Test	-
Vibration	V1 (30Hz/3g/2hr)
Recommended Charge Rate	5A

Terminal Type

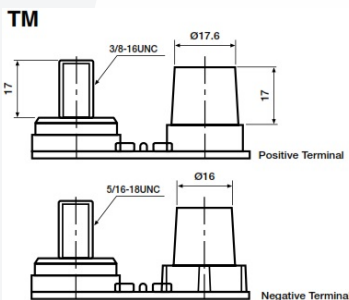

Cell Assembly Layout

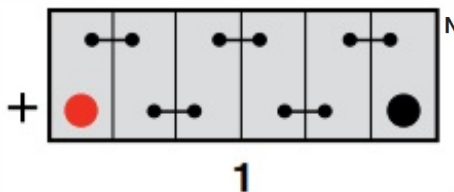

Battery Hold-down



Data Sheet generated on 25/04/2017 - E&OE